







Plaster wall		Cement wall	
A	 x6	F	 x6
B	 x6	G	 x6
C	 x6		
D	 x6		
E	 x6		

Finish



1216201

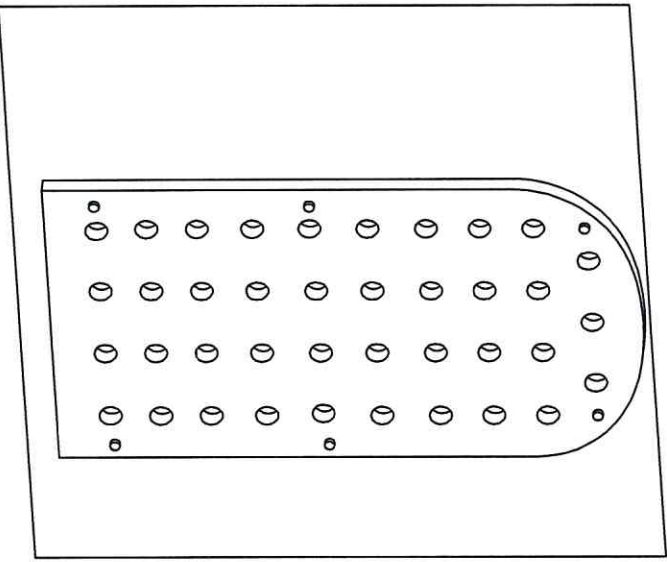
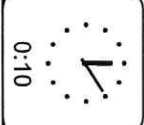
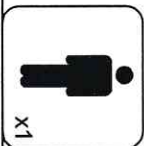

Step:1

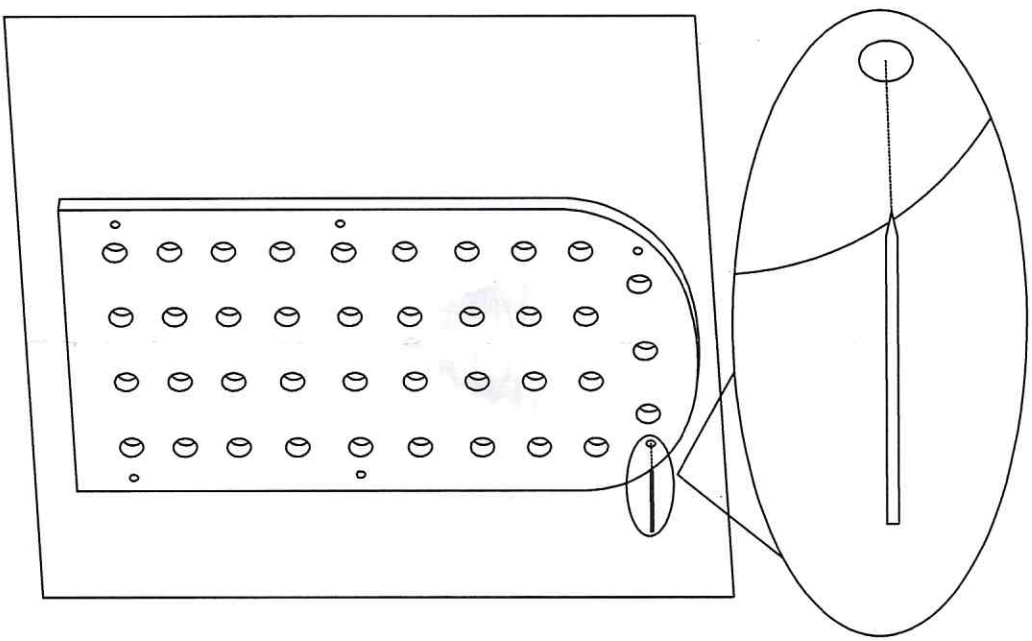

Step:2

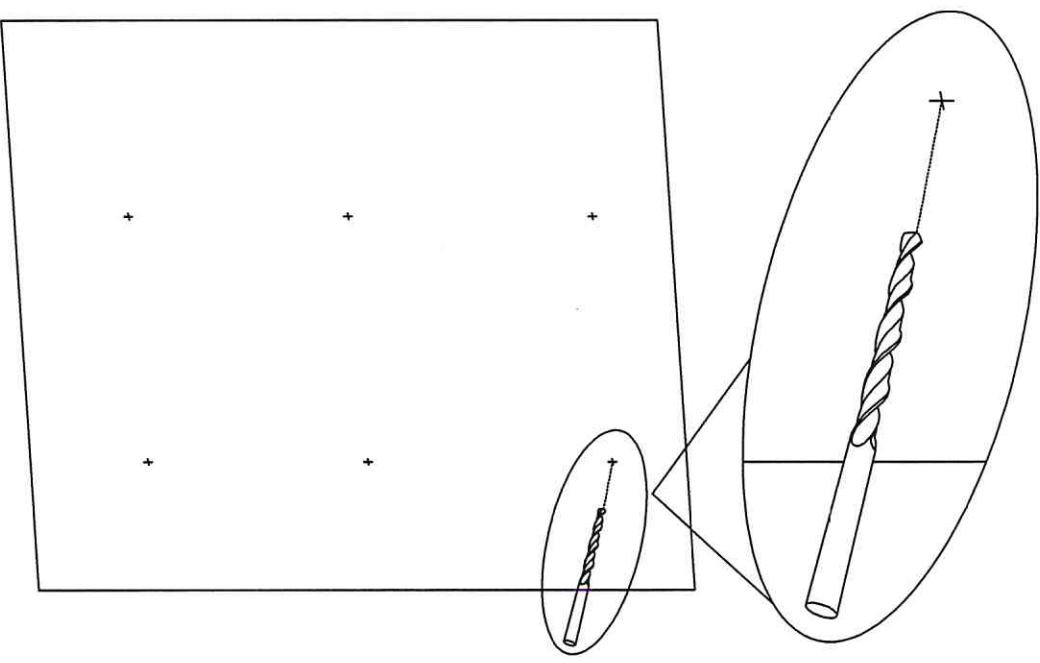

Plaster wall

Step:3

Cement wall

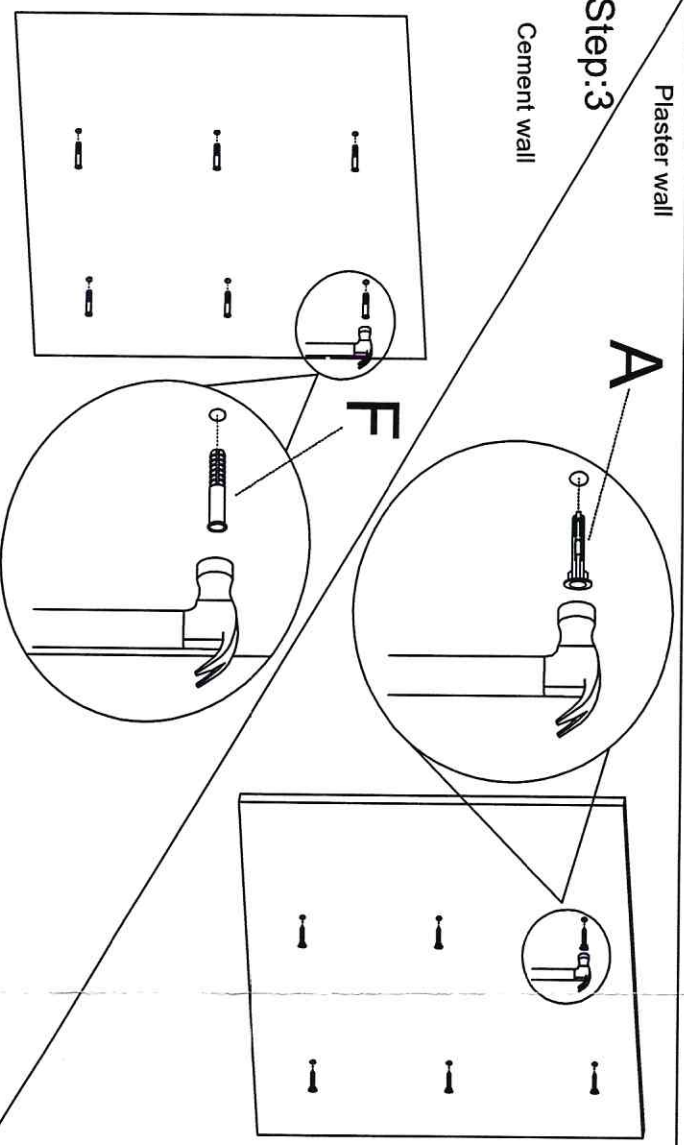

Step:5

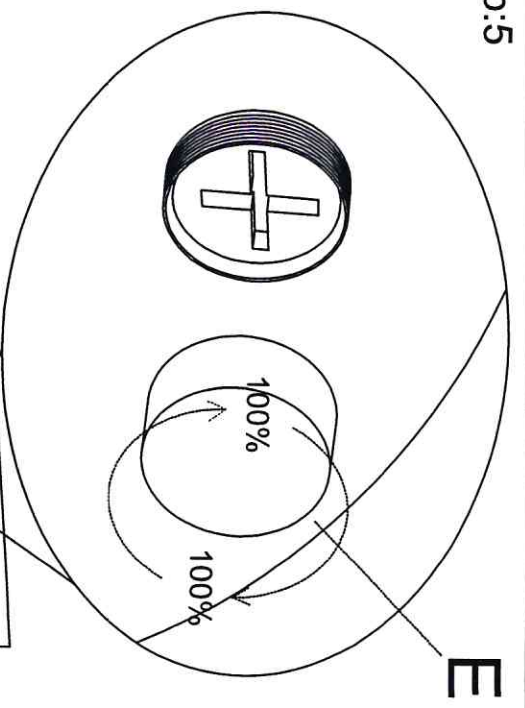

Plaster wall

Step:4

Cement wall

