

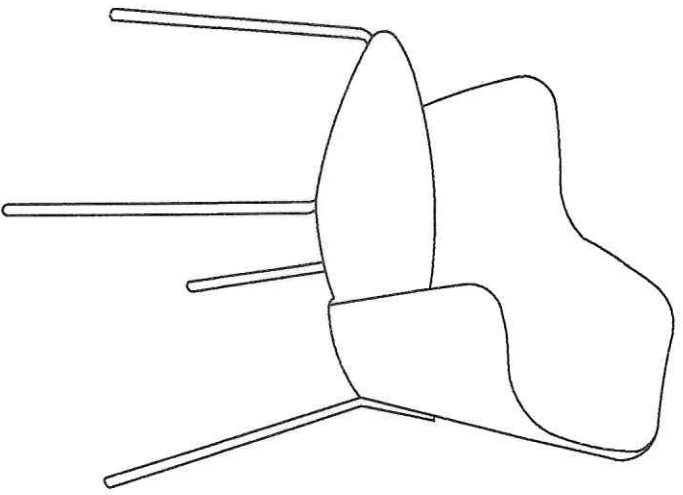





ASSEMBLY INSTRUCTIONS

DINING CHAIR MODEL# : UDC 8190

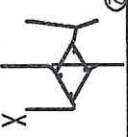

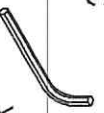
 <p>① X 1</p>	 <p>② X 1</p>
 <p>A X 4</p>	 <p>B X 4</p>
 <p>C X 1</p>	



X 1



0:10

