













Plaster wall		Cement wall	
A		F	
B		G	
C			
D			
E			
			X4
			X4
			X4

Finish

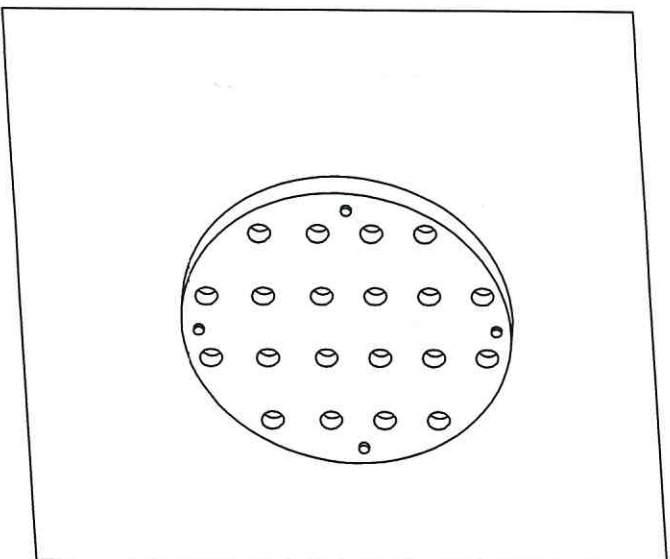

1216204



x1



0:10

Step:1

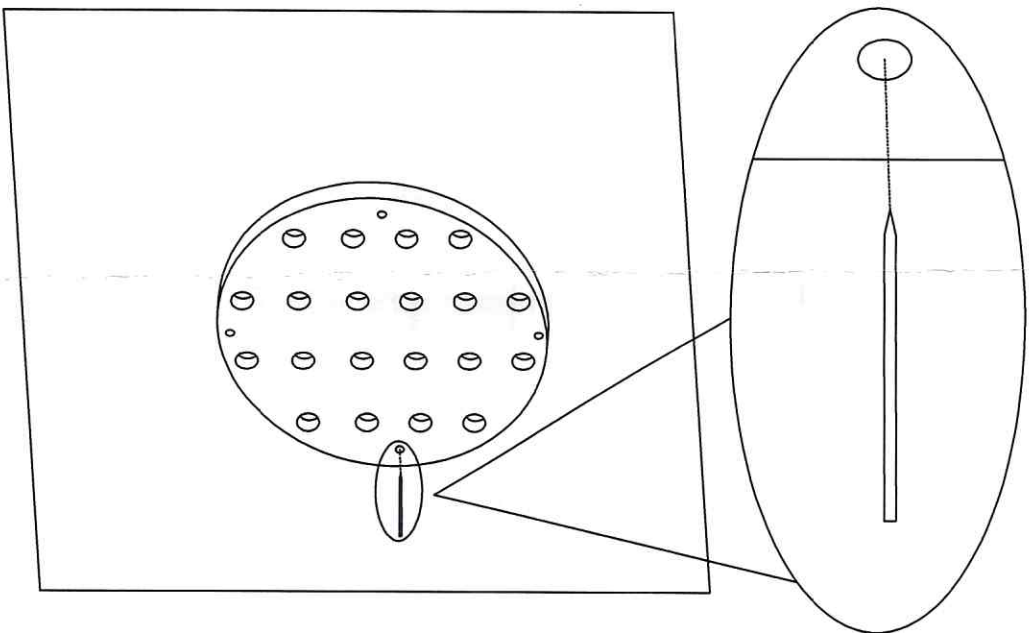

Step:2

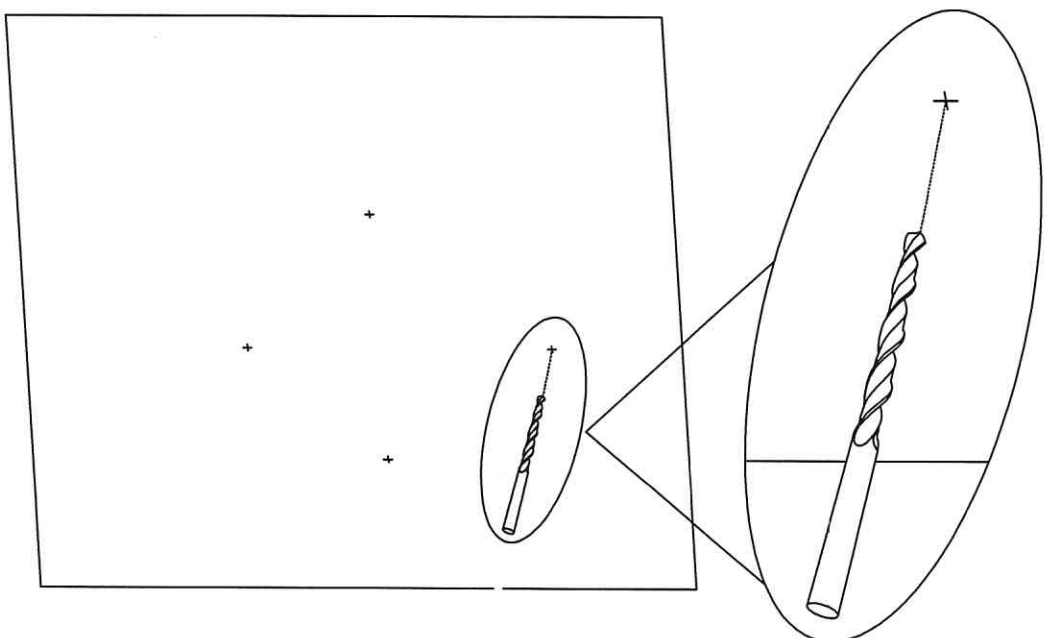

Plaster wall

Step:3

Cement wall

A

F

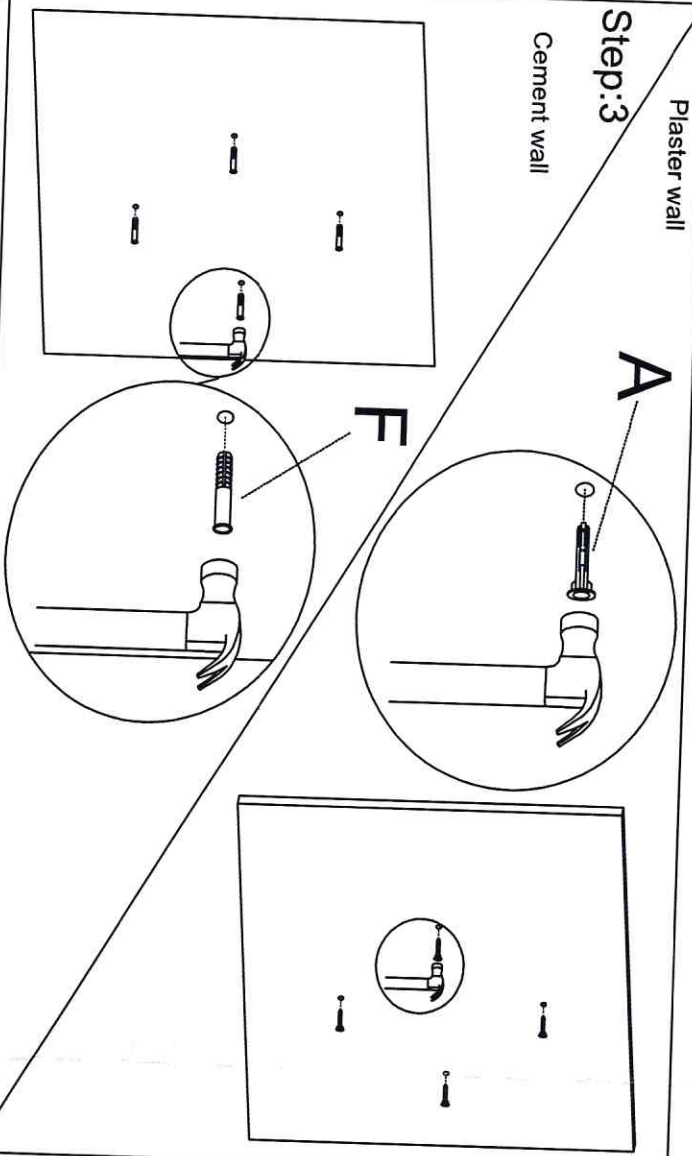

Step:5

E

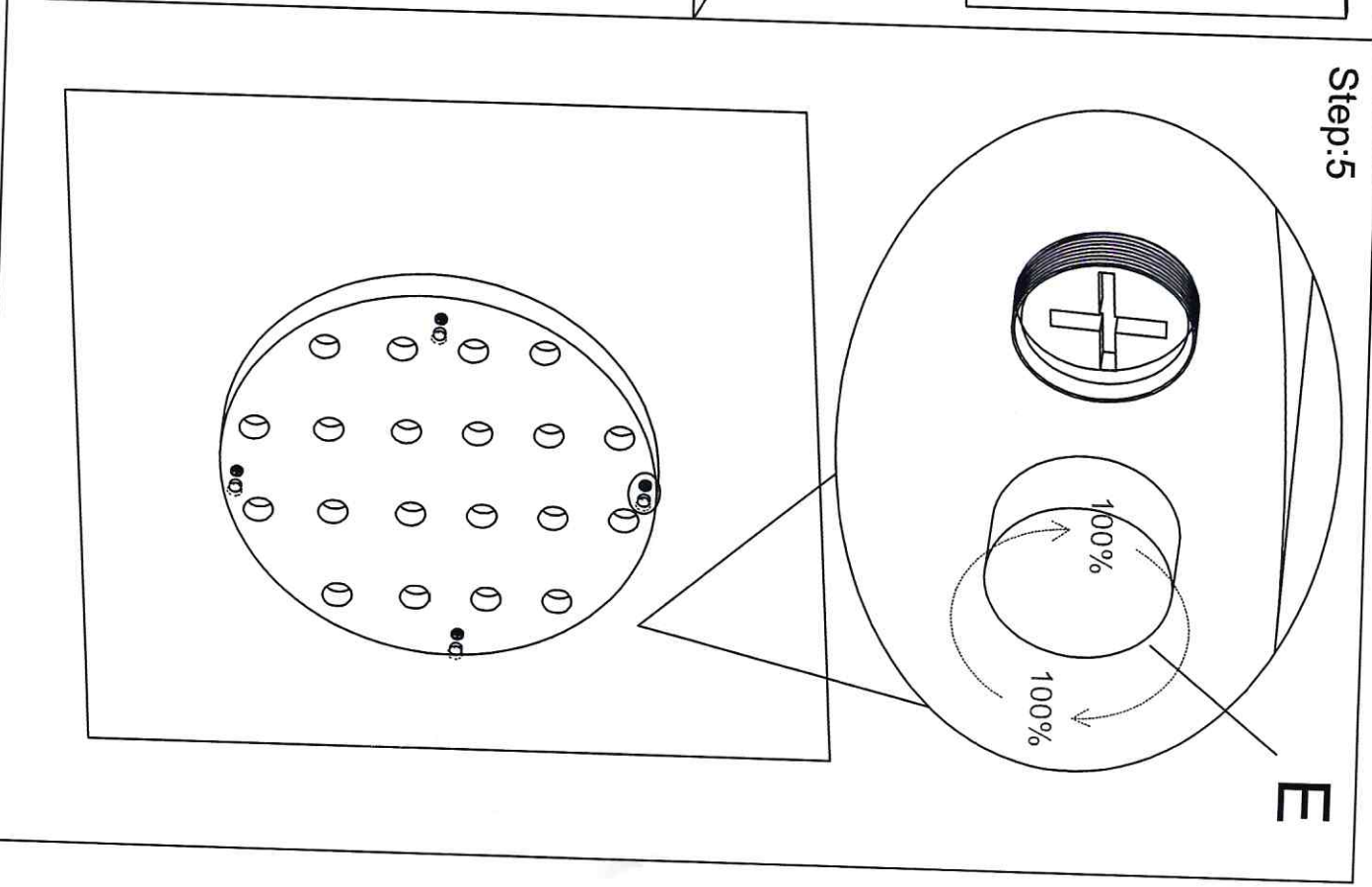

Plaster wall

Step:4

Cement wall

DCB

DCG

